

Jackery

Model: JE-2000A

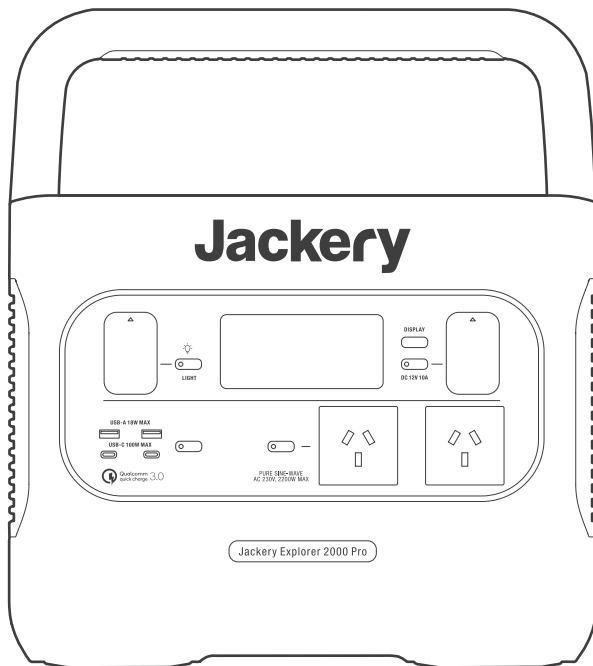

USER MANUAL

Jackery Explorer 2000 Pro

Congratulations on your new Jackery Explorer 2000 Pro. Please read this manual carefully before using the product, particularly the relevant precautions to ensure proper use. Keep this manual in an accessible place for frequent reference.

In compliance with laws and regulations, the right of final interpretation of this document and all related documents of this product resides with the Company.

Please kindly notice that no further notifications will be given in case of any update, revision or termination.

TECHNICAL SPECIFICATIONS

Product Name:	Jackery Explorer 2000 Pro
Model No.:	JE-2000A
Capacity:	Lithium-ion 50Ah/43.2V DC (2160Wh)
Size & weight:	approx. 38.4x26.90x30.75cm & approx. 19.5kg
Lifecycles:	1000 cycles to 80%+ capacity
AC Input:	230V~ 50Hz, 10A Max
DC Input:	11-17.5V(Working Voltage)===8A Max, Double to 8A Max 17.5-60V (Working Voltage)===12A, Double to 24A/1400W Max
2×AC Output:	230V~ 50Hz,9.57A,2200W Rated,4400W surge peak
2×USB-A output:	Quick Charge 3.0,18W Max, 5-6V===3A, 6-9V===2A, 9-12V===1.5A
2×USB-C Output:	100W Max, 5V===3A, 9V===3A, 12V===3A, 15V===3A, 20V===5A
Car Port:	12V===10A
Charge Temperature:	0~40 °C (32~104°F)
Discharge Temperature:	-10~40 °C (14~104°F)

CERTIFICATIONS: UN38.3



Qualcomm
quick charge 3.0

※USB Type-C® and USB-C® are registered trademarks of USB Implementers Forum.

※Qualcomm Quick Charge is a product of Qualcomm Technologies, Inc. and/or its subsidiaries.

Qualcomm and Quick Charge are trademarks or registered trademarks of Qualcomm Incorporated.

PACKAGE LIST

①

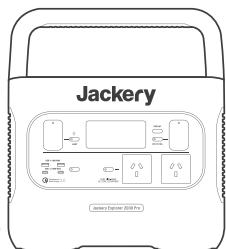

Jackery Explorer 2000 Pro ×1

②

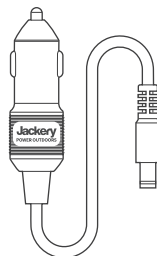

Car Charge Cable ×1

③

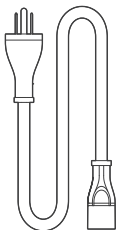

AC Charge Cable ×1

④

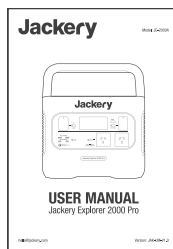

Quick Start Guide ×1

GET TO KNOW YOUR GEAR

Product Appearance

华宝新

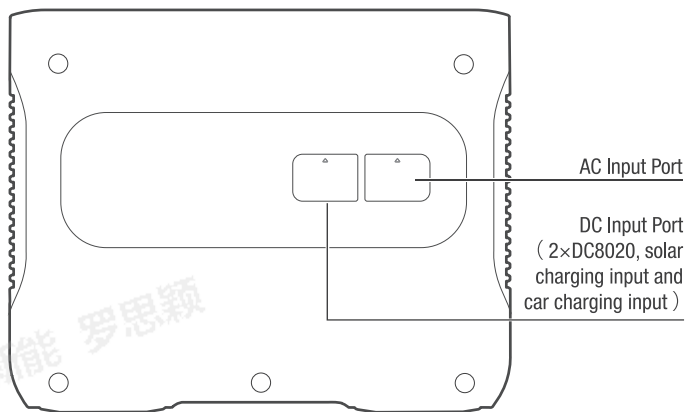
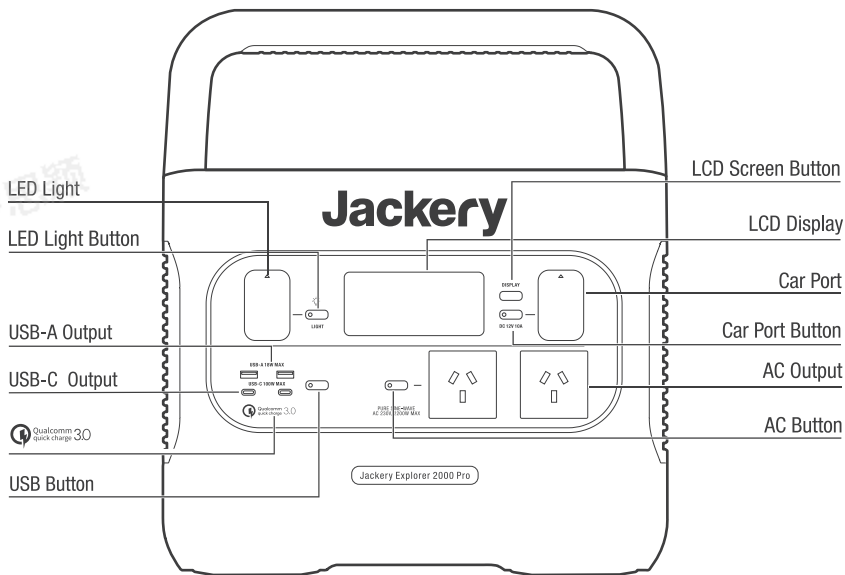

华宝新能 罗思颖

LCD Display

华宝新

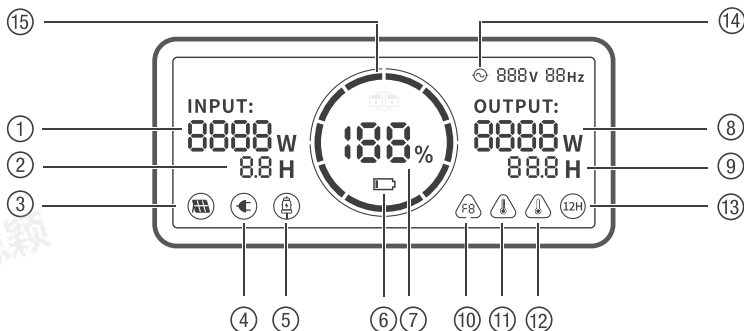

① INPUT: 8888 W 8.8 H	Input Power	⑧ OUTPUT: 8888 W 88.8 H	Output Power
② INPUT: 8888 W 8.8 H	Remaining Charge Time	⑨ OUTPUT: 8888 W 88.8 H	Remaining Discharge Time
③	Solar Charging Indicator	⑩	Error Code
④	AC Wall Charging Indicator	⑪	High Temperature Warning
⑤	Car Charging Indicator	⑫	Low Temperature Warning
⑥	Low Battery Indicator	⑬	Low Power Mode
⑦ 188%	Remaining Battery Percentage	⑭	AC Power Indicator
⑮	Battery Power Indicator		

Battery Power Indicator () :

When the product is being charged, the orange circle around the battery percentage will light up in sequence. When charging other devices, the orange circle will stay on.

Low Battery Indicator () :

When the battery is less than 20%, the Low Battery Indicator will stay on. When less than 5%, the Low Battery Indicator will flash. When it is being charged, the Indicator will be off.

Low Power Mode () :

To avoid forgetting to turn off the output during use that results in battery consumption, the product turns the Low Power Mode off by default. This occurs when no device is connected or the connected device is less than or equal to a certain value. (Refer to the table below for more details), the device will automatically shut down after 12 hours.

Output	Output Power	Defaults
AC Output	$\leq 25W$	The device will automatically shut down after 12 hours
USB Output	$\leq 2W$	The device will automatically shut down after 12 hours
Car Output	$\leq 2W$	The device will automatically shut down after 12 hours

To turn on the Low Power Mode: Long press the AC Button and DISPLAY Button until the Low Power Mode icon lights up. In Low Power Mode, please remember to turn off the output to avoid battery consumption.

To turn off the Low Power Mode: Long press the AC Button and DISPLAY Button until the Low Power Mode icon disappears on the screen.

Error Code () :

If the codes F0 to F9 appear on the screen, please refer to the troubleshooting guide or contact our customer service for help.

BASIC OPERATIONS

Power On/Off

AC Output On/Off: Press the AC Button, the AC Output operation indicator lights up. Then you can connect the equipment that needs AC charging. Press the AC Button again to turn off the AC Output.

USB Output On/Off: Press the USB Button, the USB Output operation indicator lights up. Then USB-A and USB-C Output Ports can be connected to external load devices. Press the USB Button again to turn off the USB Output.

Car Port On/Off: Press the Car Port Button, the Car Port operation indicator lights up. Then the Car Port can be connected to the external load devices. Press the Car Port Button again to turn off the output.

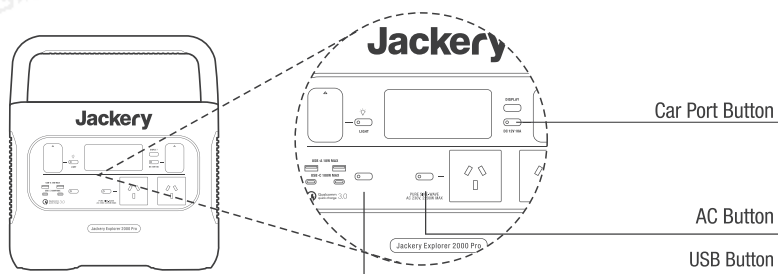

LCD Screen On/Off

To Turn On, press the DISPLAY Button, any Output Power Button, or LED Light Button. Or, when there's a charging input, the screen display will light up automatically.

To Turn Off, press the DISPLAY Button again and the screen display will turn off. Or, if there is no operation in 30 seconds, the product will enter a sleep state and the screen display will automatically turn off.

To get the screen always-on (under charging or discharging state), follow these steps: After the display screen lights up, double-click the DISPLAY Button and the mode of Always-On Display will be on.

To turn off Always-On Display, follow these steps: Press the DISPLAY Button and the screen will be turned off in 30 seconds.

Tip:

During Always-On mode, the screen automatically turns off after 2 hours without charging or discharging.

LED Light On/Off

There are three modes of LED Light: Low Light mode, Bright Light mode, and SOS mode.

The operations are as follows: Press the LED Light Button, the LED will be turned on. The light will always turn on in Low Light mode and the output power on the screen is 1W. Press again to enter the Bright Light mode and the output power on the screen is 3W. Press the third time to enter the SOS mode and the output power on the screen is 3W. Then, press again to turn off the LED Light. In any of these modes, the light can be turned off by a long press.

CHARGING YOUR JACKERY EXPLORER 2000 PRO

Green energy first: We advocate to use the green energy first. This product supports two modes of charging at the same time: solar charging and AC wall charging.

When AC wall charging and solar charging are turned on at the same time, the product will give priority to solar charging and both methods will be used to charge the battery at the maximum permissible power.

Charging from the wall

Please use the AC cable included in the package.

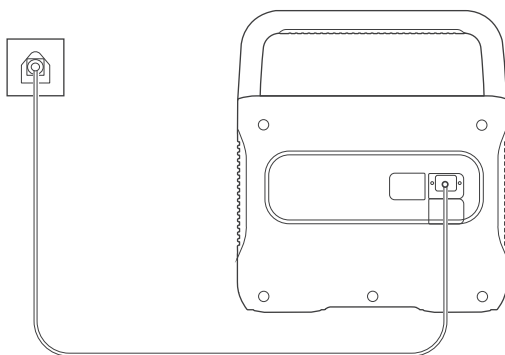

AC Charger

Explorer 2000 Pro

Charging from Solar

Solar Generator Connector (Tip: This accessory is sold separately)

Two or three solar panels can be connected in series through this adapter. To ensure that the solar panels can exert the maximum power output, please make sure to use the same type of solar panels when connected in series.

Functions of Main Ports

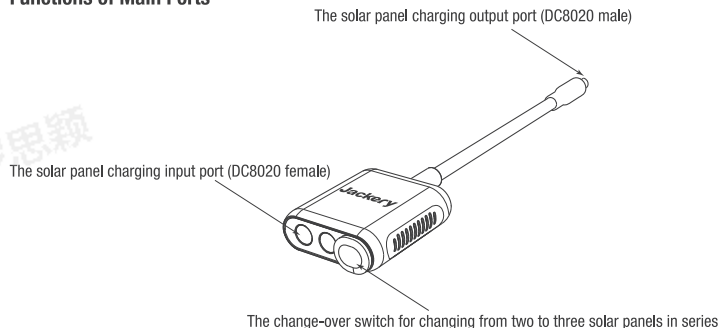

- 1 The solar panel charging output unit port (DC8020 male): When charging, plug this port into the DC input port of the Jackery Explorer 2000 Pro.
- 2 The solar panel charging input port (DC8020 female): When charging, connect solar panel(s) to this port.
- 3 The change-over switch for changing from two to three solar panels in series: When connecting two solar panels to charge, the switch should be kept OFF, otherwise it cannot be charged. If the switch is ON, three solar panels need to be connected at the same time to use it.

How to Use (Take 200W Solar Panel As An Example)

Jackery SolarSaga solar panels (100W and 200W) are equipped with 2 port types at the output interface. Please refer to the following illustrations to connect the solar panel and the adapter.

When connecting two 200W solar panels, please operate as follows:

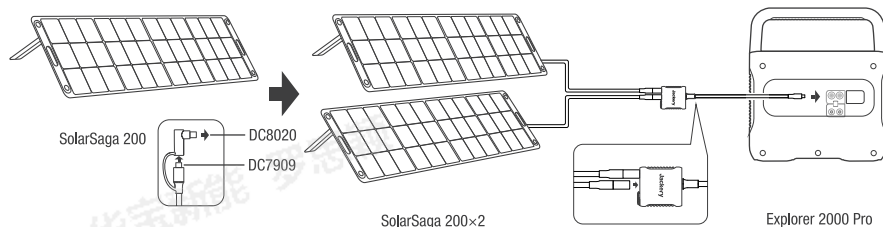

When connecting three solar panels, please operate as follows:

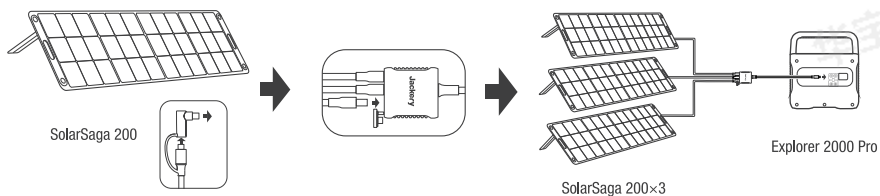

Connection Operation Instructions: When charging, please connect the connector to the DC input port of the power station before connecting the solar panel. When the power station is fully charged, make sure to remove the solar panel first, then remove the connector from the power station.

Solar Panels Connection Guide

Users can use our solar panels to charge this product in series or parallel as shown in the following illustrations.

Example 1

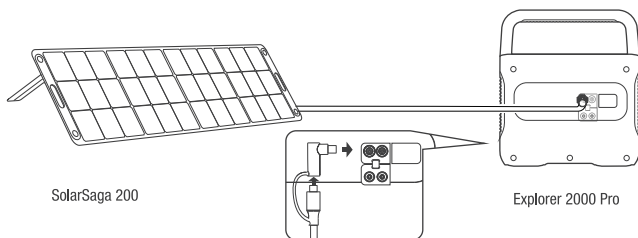

Example 2

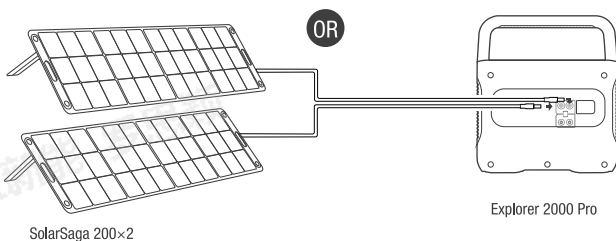
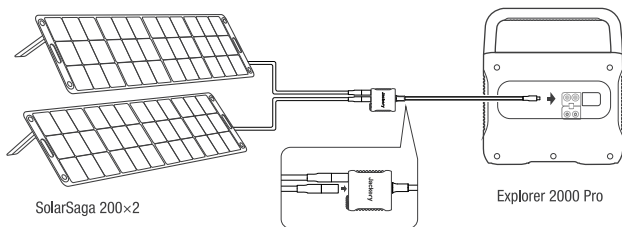

Example 3

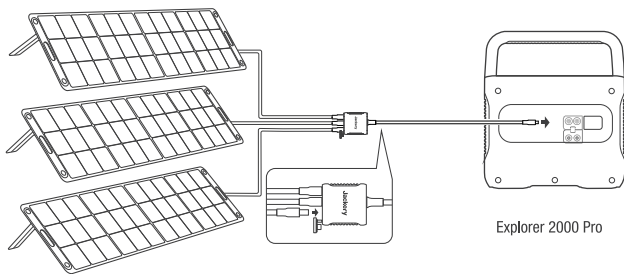

SolarSaga 200×3

Explorer 2000 Pro

Example 4

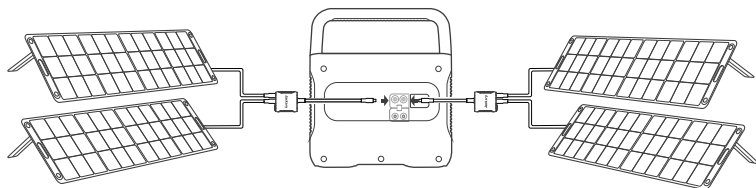

SolarSaga 200×2

Explorer 2000 Pro

SolarSaga 200×2

Example 5

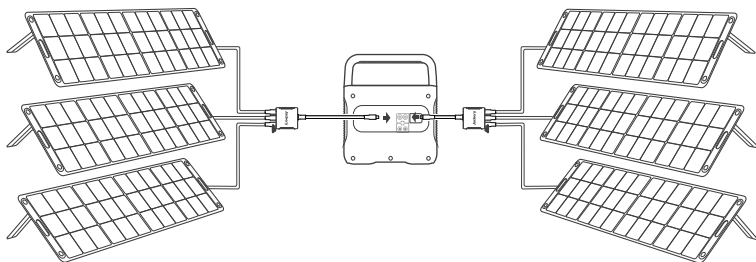

SolarSaga 200×3

Explorer 2000 Pro

SolarSaga 200×3

Caution: When the two inputs are used at the same time, please make sure to use the same type of solar panel and the number of solar panels in the two inputs must be the same to avoid damage or charging problems of the equipment due to inconsistent voltages of the two channels.

The following way of connections are prohibited to charge this product:

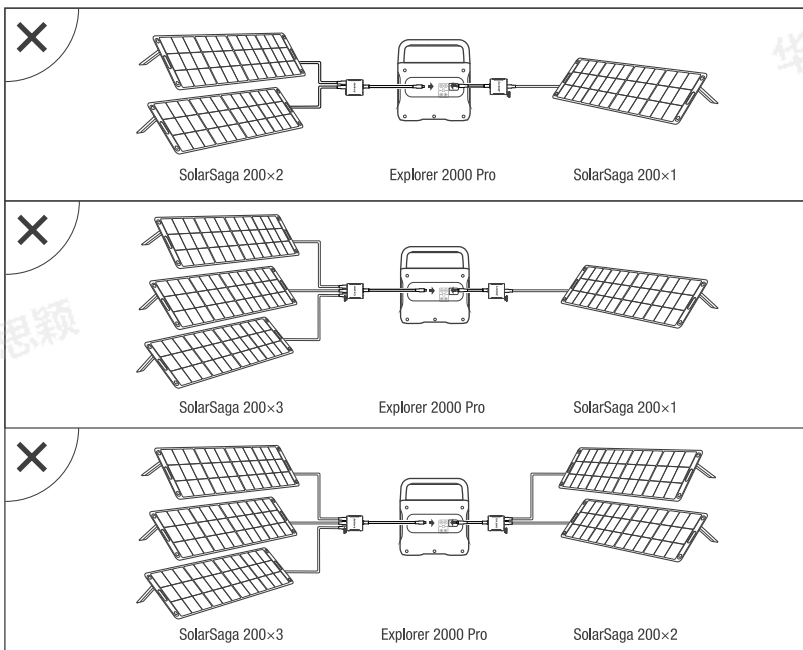

Charging in the Car

This product can be charged with a 12V car charger. Please start the vehicle before charging to prevent draining the car battery and prevent your vehicle from being unable to start.

Meanwhile, please ensure that the car charger and the car cigarette lighter provide a good connection, and ensure that the car charger is fully inserted. In addition, if the vehicle is running on bumpy roads, it is forbidden to use the car charger in case it burns due to a poor connection. The Company will not be responsible for any loss caused by non-standard operation.

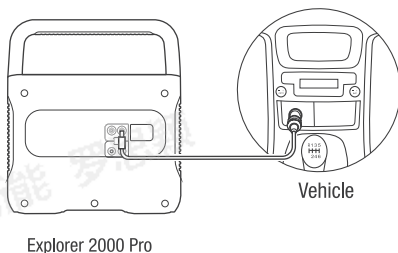

SAFETY PRECAUTIONS WHEN CHARGING

- 1 When the two DC inputs of this product are used at the same time, please ensure that the number of solar panels connected in series is the same, and try to use the same type of solar panel.
- 2 Do not charge from car charger and solar panel at the same time, otherwise, it will damage the car fuse.

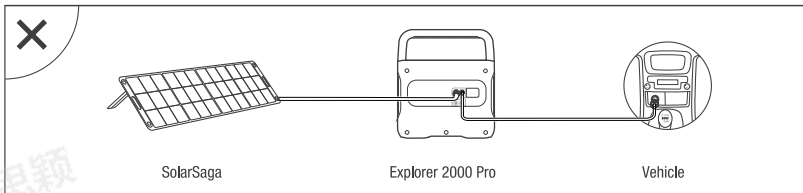

- 3 Vehicle charging is only applicable in 12V vehicles, not in 24V ones. Please do not charge this product in 24V vehicle to avoid personal injury and property loss.
- 4 It is recommended to use Jackery accessories - solar panels for solar charging. We will not be responsible for the losses caused by using other brands' solar panels.

SAFETY PRECAUTIONS WHEN USING

The basic safety precautions should be followed when using this product, including:

- a. Please read all instructions before using this product.
- b. Close supervision is required when using this product near children to reduce the risk.
- c. Risk of electric shock may occur if using accessories recommended or sold by non-professional product manufacturers.
- d. When the product is not in use, please unplug the power plug from the product's socket.
- e. Do not dismantle the product, which may lead to unpredictable risks such as fire, explosion or electric shock.
- f. Do not use the product through damaged cords or plugs, or damaged output cables, which may cause electric shock.
- g. Charge the product in a well ventilated area and do not restrict ventilation in any way.
- h. Please put the product in a ventilated and dry place to avoid rain and water to cause electric shock.
- i. Do not expose the product to fire or high temperature (under direct sunlight or in vehicle under high heat), which may cause accidents such as fire and explosion.

FAQ

Q: Can the product be brought on board a plane?

A: No, because this product is a lithium battery. According to the International Standards & Regulations for the Transportation of Hazardous Materials, no lithium batteries with more than 100 watt hours may be allowed in carry-on bags.

Q: Why is there sound when using?

A: The product adopts an air-cooled system, and the built-in fan helps the product to cool better. Slight noise when using is normal.

Q: Can I charge the Jackery Explorer 2000 Pro while a device is plugged in?

A: Yes, you can. When charged with AC input, it supports a maximum power output of 2200W. When charged with AC input + DC input (i.e. solar charging or car charging) simultaneously - it supports a maximum power output of 2200W. When charged with DC input (i.e. solar charging or car charging), it supports a maximum power output of 2200W.



Q: How to keep this product when it is not used for a long time?

A: If the battery is to be unused for a long time (more than 3 months), it should be maintained at 60-80% of the rated capacity (it's recommended to check and charge every 3 months). Store it in a dry and cool place with temperature range between 0 ℃~40 ℃, and humidity 0%~60%. Avoid contact with corrosive substances, and far from fire and heat sources.

Q: Can it be used to jump start a car?

A: We are very sorry, but it cannot be used to jump start a vehicle. However, it can be used as power supply for automobiles. You can recharge the car via a Jackery power supply cord, which is available for purchase separately.













Q: Why is the output to the low-power device automatically turned off after several hours?

A: In case of forgetting to turn off the output (causing the battery to drain), the Low Power Mode will be turned off by default. That is, when the port is connected to a small load device(AC Output≤25W, USB Output≤2W, Car Port≤2W) for 12 hours, the device will automatically be turned off. In case you want to resume recharging, press the car port button/USB button/AC button to restart the device. If you want to turn on the Low Power Mode, long press the AC Button and DISPLAY until the Low Power Mode icon  appears on the screen. If you need to turn off the Low Power Mode, repeat the above operation until .

Q: Why does the USB Output operation indicator light up, the load device has no charging input or can't work normally?

A: Please check whether the load device is broken firstly. If the device is normal, press the USB Button to restart the output.

TROUBLESHOOTING

Errors	Types	Solutions
Error Code (F0-F9)	 BMS communication failure	Contact after-sales service
	 inverter communication failure	Contact after-sales service
	 charging module communication failure	Contact after-sales service
	 battery failure	Contact after-sales service
	 battery over-voltage	Contact after-sales service
	 battery under-voltage	Contact after-sales service
	 inverter error	Contact after-sales service
	 charging module error	Contact after-sales service
	 Overcurrent/short circuit charging or discharging protection	Resolve the problem by pulling out plug or electrical appliances, the product can recover itself. If not solved, please contact our after-sales service.
 DC output overcurrent/short circuit protection	Resume operation by pulling out electrical appliances, the product can recover itself. If not solved, please contact our after-sales service.	
	High temperature warning	The product can recover itself after battery is cooled
	Low temperature warning	The product can recover itself after the ambient temperature increases

WARRANTY

Note: We only provide our warranty for the buyer who purchased on Amazon (Jackery Inc), Jackery website or local authorized dealers.

Limited Warranty

Jackery Inc. warrants to the original consumer purchaser that the Jackery product will be free from defects in workmanship and material under normal consumer use during the applicable warranty period identified in the 'Warranty Period' section below, subject to the exclusions set forth below.

This warranty statement sets forth Jackery's total and exclusive warranty obligation. We will not assume, nor authorize any person to assume for us, any other liability in connection with the sale of our products.

Warranty Period

3 Years Standard Warranty: The standard warranty period for Jackery Explorer 2000 Pro is 36 months. In each case, the warranty period is measured starting on the date of purchase by the original consumer purchaser. The sales receipt from the first consumer purchase, or other reasonable documentary proof, is required in order to establish the start date of the warranty period.

2 Years Extended Warranty: To activate the Warranty Extension, you must register your product online or contact our customer service team at hello@jackery.com to extend the standard warranty runtime.

Exchange

Jackery will replace (at Jackery's expense) any Jackery product that fails to operate during the applicable warranty period due to defect in workmanship or material. A replacement product assumes the remaining warranty of the original product.

Limited to Original Consumer Buyer

The warranty on Jackery's product is limited to the original consumer purchaser and is not transferable to any subsequent owner.

JACKERY AUSTRALIA PTY LTD

Address: 39 ANTIBES ST PARKDALE VIC 3195

E-mail: hello@jackery.com

Website: www.jackery.com